

gift sack



Our simple free Santa Sack pattern is lovely idea for some Christmas sewing which not only reduces wrapping paper used and a huge amount of time on Christmas eve, but is also a present in itself. This gift sack will light up the face on any child (or adult!) and can be used year to year.

sew knit love
- - - - v v v v x x x x

-
1. Cut out pattern pieces using your own measurements calculated on the blog post.

Lining: _____x_____

Outer: _____x_____

Tie: _____

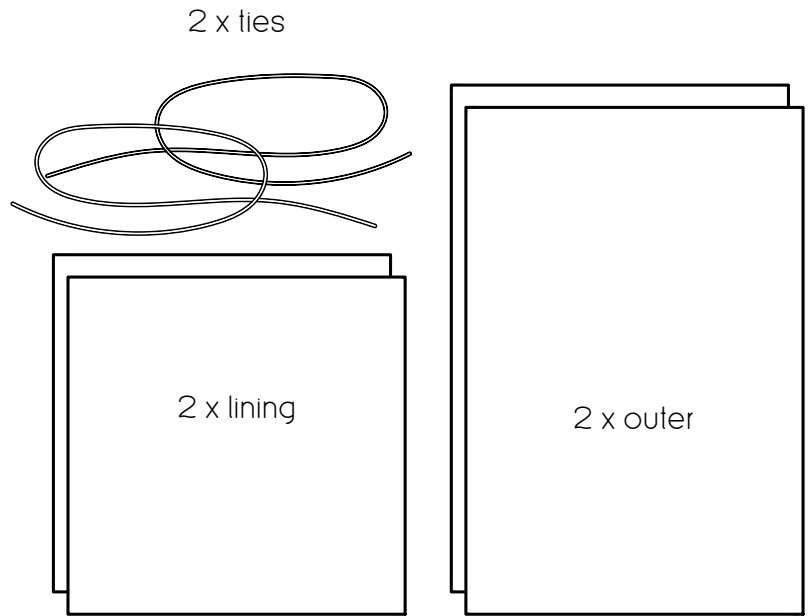

-
2. Mark the hole bottom and top on the inside of your outer fabric. Use an air erasable marker, wax or if your fabric is dark use a pencil for this as it will need to stay put for a while.

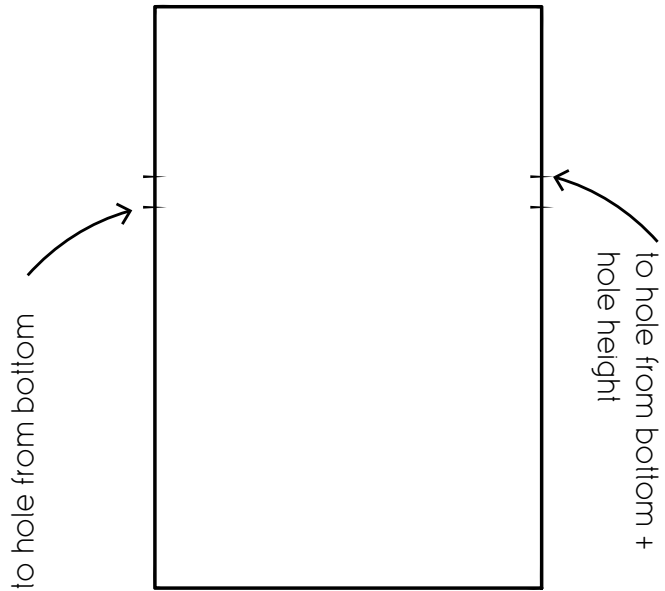

-
3. Right sides together, sew the lining as shown, leaving a gap at the bottom.

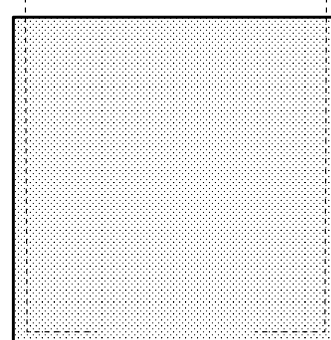

-
4. Right sides together, sew the outer as shown. Leave a gap for the ties where you have marked on each side. Backstitch the edge of each hole.

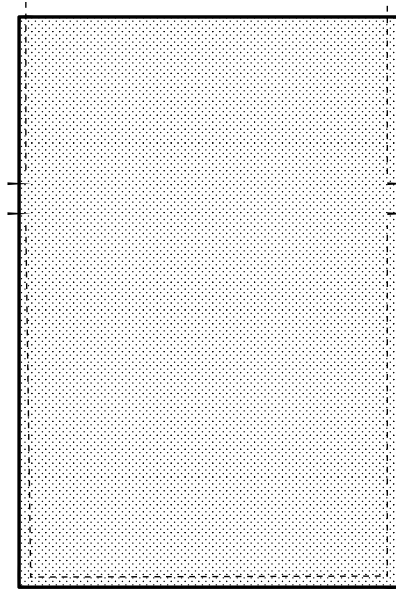

-
5. Sew the lining to the outer: turn the lining right way out and insert into the outer, right sides are together. Sew around the edge as shown.

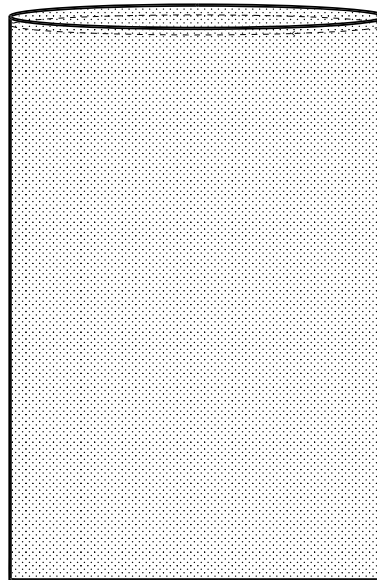

-
6. Turn right way out through the hole in the bottom of the lining. Fold the seam allowance inward and topstitch closed as shown.

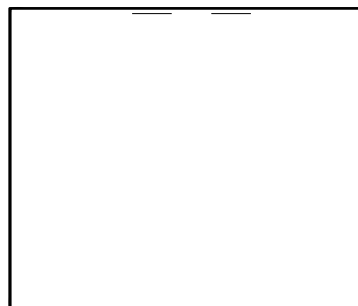

-
7. Bring the lining bottom corners together with the outer corners. Pin to keep in place. Manipulate your bag so that it is all sitting flat, seam to seam.

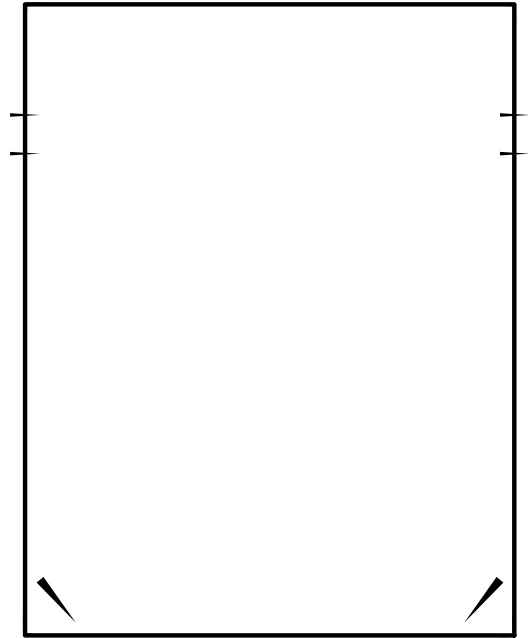

-
8. Find the bottom of your tie hole on each side and place a pin in the seam. You will topstitch all the way around on the bottom and the top to keep the ties in place. Using an air erasable marker rule a straight line around, and sew. Repeat for the top of the hole.

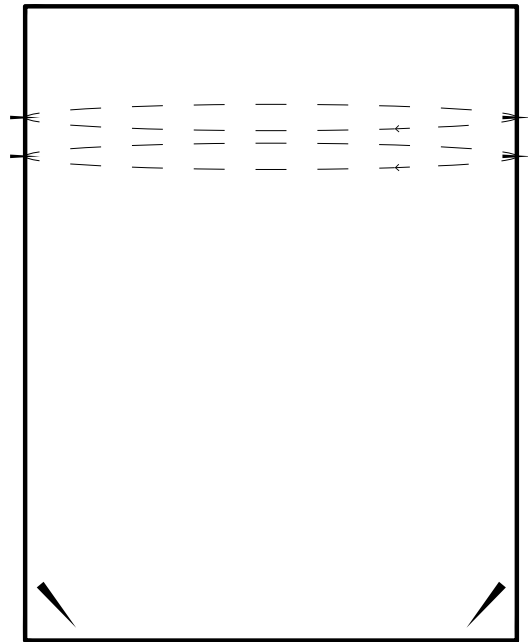

-
9. Thread tie through the channel you have just sewn using a safety pin, and bring it back through the same hole. Repeat for the second tie through the other hole.

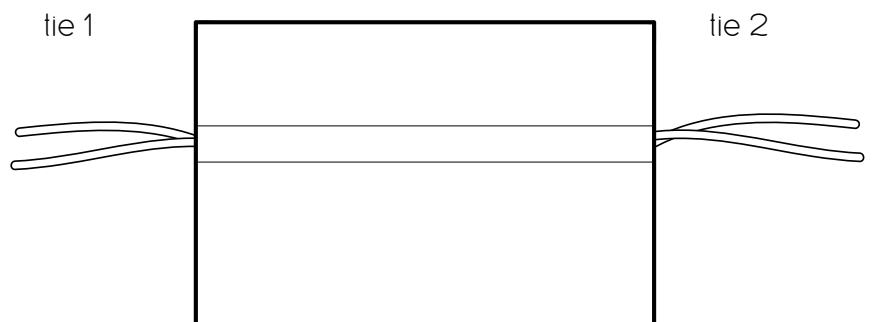

10. Make some pompoms
or tassels for the ends
of your ties.

11. Fill with gifts! Tag us on
Instagram
@sewknitlove, we
really enjoy seeing your
creations.